

**PERFORM  
BETTER**

# FLOORING

**Rig & Rack**

**PERFORM  
BETTER**



Perform Better combines expertise and passion to help people become fitter, stronger and healthier. To do this, we offer high-quality products as well as customized solutions for gyms, sports clubs, personal trainers or physio practices to meet individual needs.

Our expertise and passion for training and health make us a reliable partner for anyone who wants to achieve their goals.

 [perform\\_better\\_europe](https://www.instagram.com/perform_better_europe)

 [Perform Better Europe](https://www.youtube.com/Perform Better Europe)

# PB FLOORING · RIG & RACK



Turf

4



Connect

8



Standard

11



Rollware

14



Outdoor

16



Puzzles

18



RIG & Rack

21

# TURF

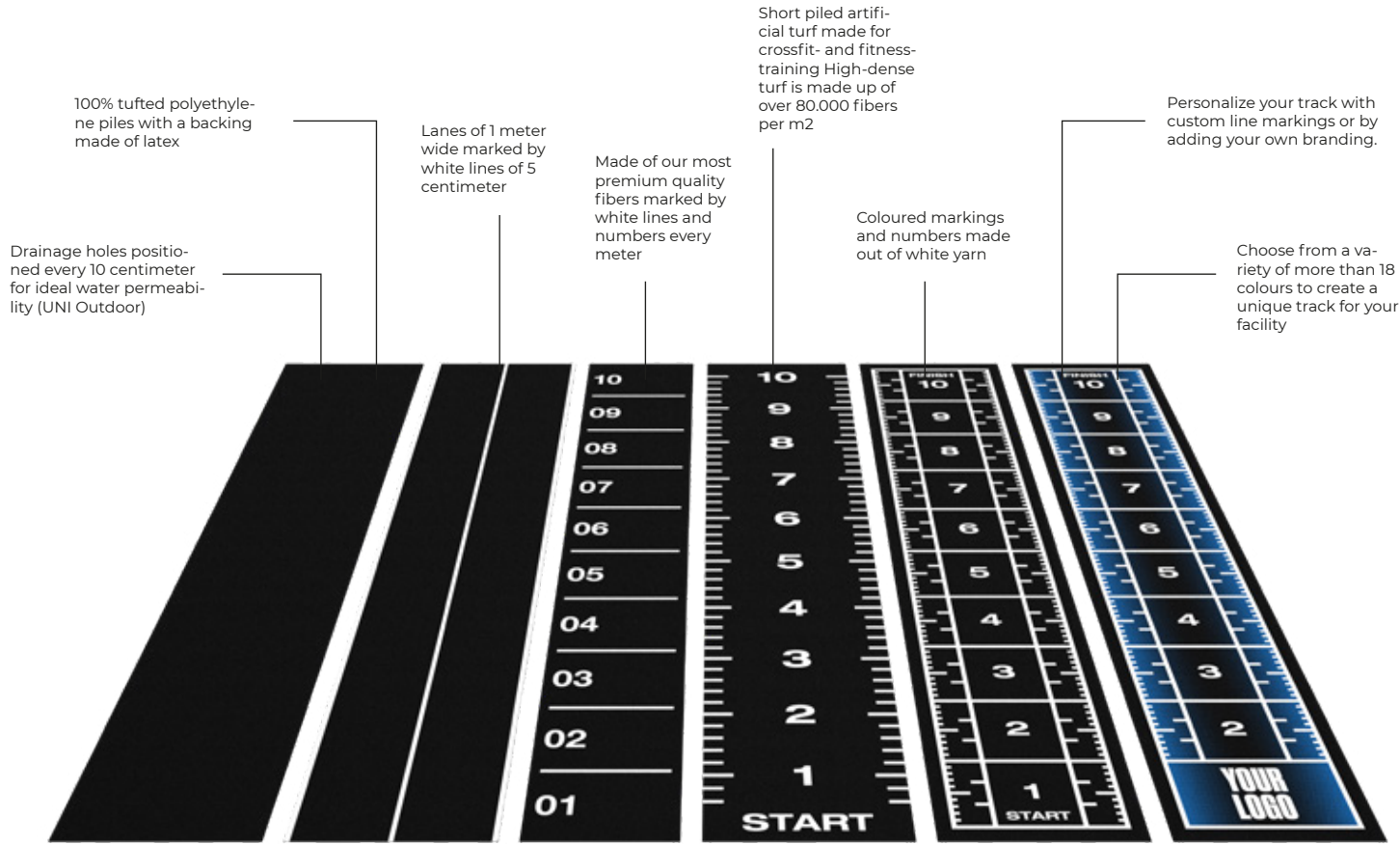

**UNI INDOOR & OUTDOOR**

**UNI SPRINT**

**CORE RANGE**

**ESSENTIAL RANGE**

**PREMIUM RANGE**

**CUSTOM TURF**

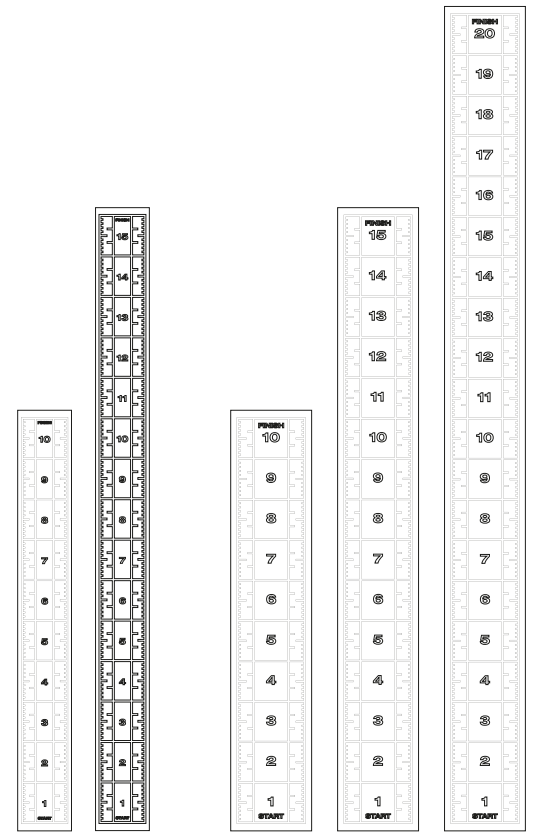
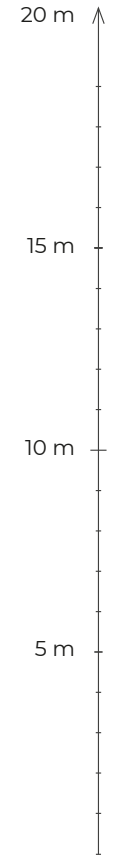

Wide 1,33 m

Wide 2 m

UNI INDOOR



UNI SPRINT

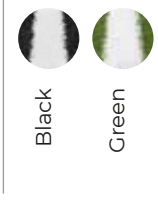

UNI OUTDOOR

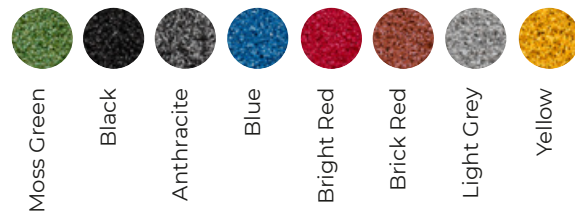

ESSENTIAL RANGE



CORE RANGE



PREMIUM RANGE

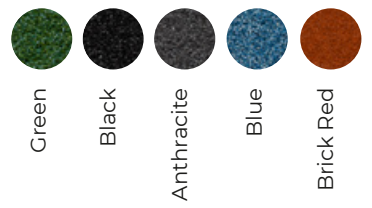



1

2

3

4

5

6

7

8

9

10

**FT-CLUB**  
FUNCTIONAL TRAINING

# CUSTOM TURF

## STEP 1

### SHARE YOUR VISION. WE MAKE IT COME TRUE!

Describe your idea to us in as much detail as possible and we will transform your vision into a custom turf within 24 hours! Do you have specific ideas, how the markings should look like?

Should we put a START or FINISH lettering at the beginning or end of your lawn?

## STEP 2

### CATEGORY A:

For example, you can choose any two colors from Category A, at no extra charge:



### CATEGORY B:



You can choose up to 6 colors per lane, should you need more than 2 colors from the category A or at least one color from category B, an extra charge will be made. Surcharge – see price calculator in our price list.

## STEP 3

Send your design request to [sales@perform-better.de](mailto:sales@perform-better.de)

Send a clear sketch by e-mail (a photo with your cell phone, a PowerPoint or Excel file) and attach your personal branding or Logo as a vector file (.pdf, .ai, .eps, .svg.). In addition, a floor plan helps for an overall impression and concrete planning.

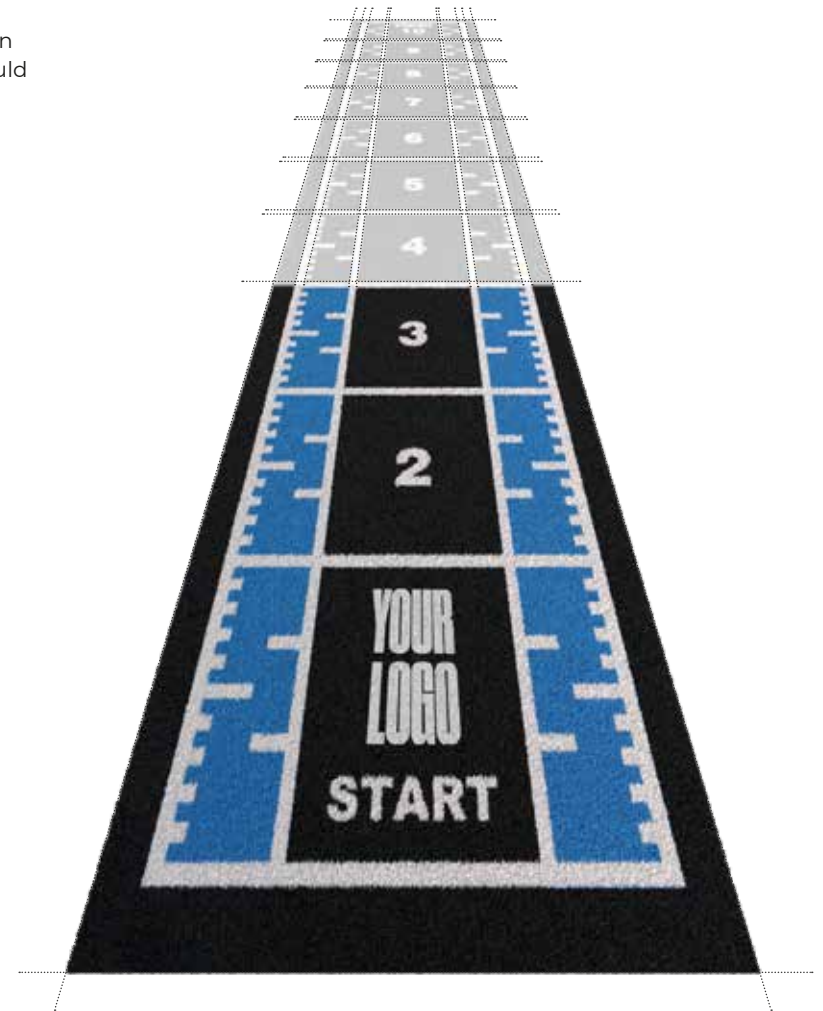



# CONNECT Tiles

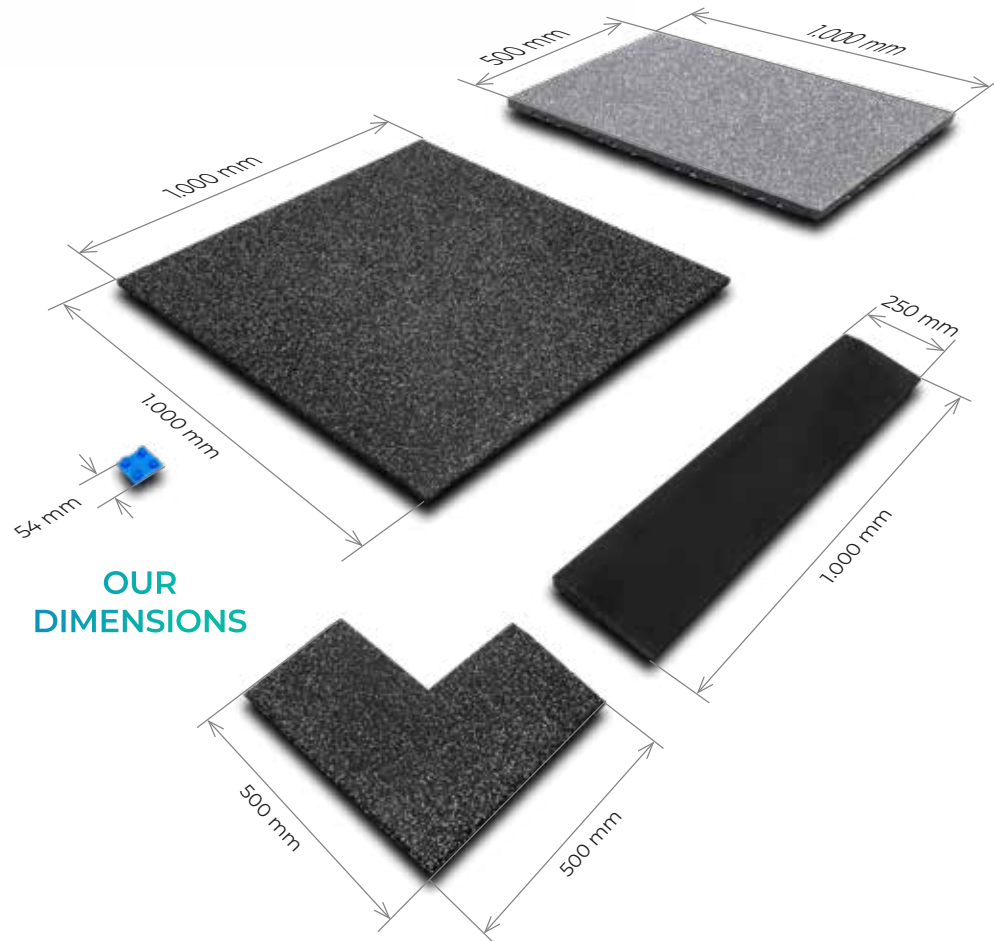

OUR DIMENSIONS

## WIDE PALETTE OF COLORS

### 20 mm Thickness

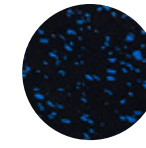

15% Blue

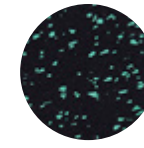

15% Green

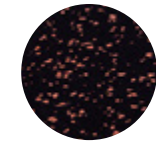

15% Red

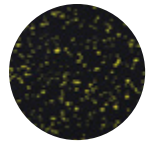

15% Yellow



Beach



Desert

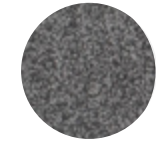

Stone



Granite

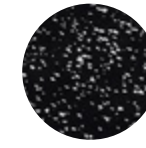

15% Light Grey



15% Dark Grey



100% Pure Black

### 30 mm Thickness

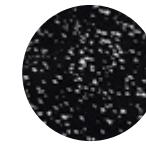

15% Light grey



15% Dark Grey

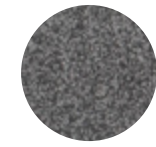

Stone



100% Pure Black

### 40 mm Thickness

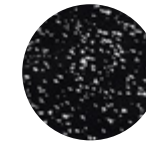

15% Light Grey

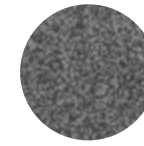

Stone

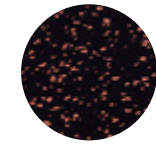

15% Red

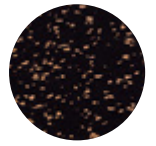

15% Orange

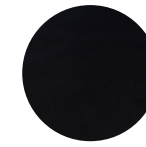

100% Pure Black



# CONNECT (TILES)

The fitness tiles are easy to install with the help of the plug-in system, gluing is not required. The edges can be covered with a stainless steel or aluminum profile. can be covered.

The tiles can be easily cut to the right size with a hand knife, although we recommend the use of carpet knives (cutters). Use a Rubber mallet to close the joints.

## THE CONNECTION SYSTEM

A „connector“ (connector) is placed every 20 centimeters, resulting in an average use of 5 connectors per meter. This and the fact that our connectors are made of polypropylene, ensures that the tiles stay perfectly in place after connecting.

The result is a phenomenal, free-floating system that can be installed without the need for adhesives or other complicated installation methods.

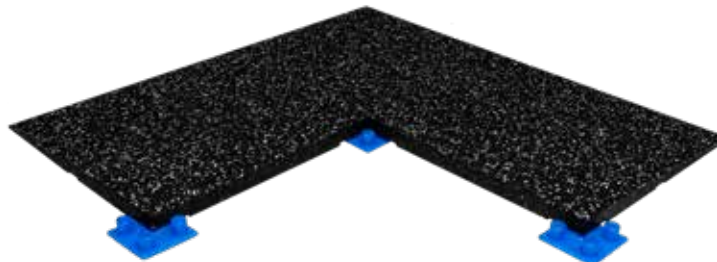

SIDE VIEW + CONNECTORS



VIEW FROM BELOW + CONNECTORS

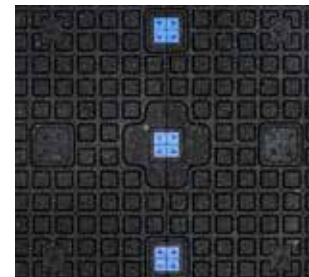
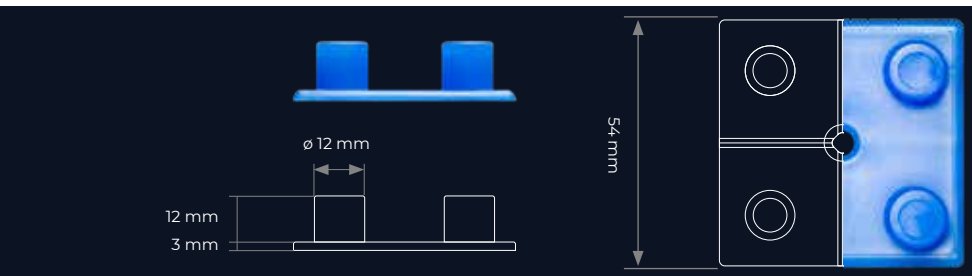
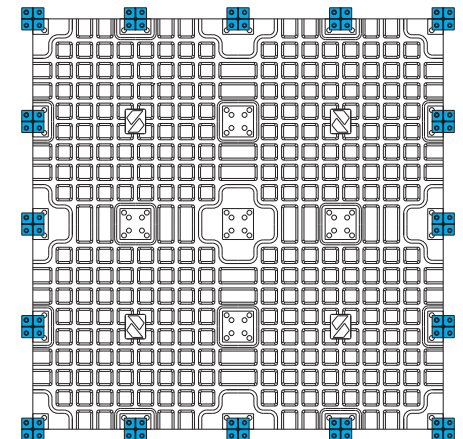

# ADVANTAGES



EASY TO CLEAN



EASY TO INSTALL



COMPREHENSIVE 5-YEAR WARRANTY



ACOUSTICAL QUALITIES



# STANDRARD Tiles

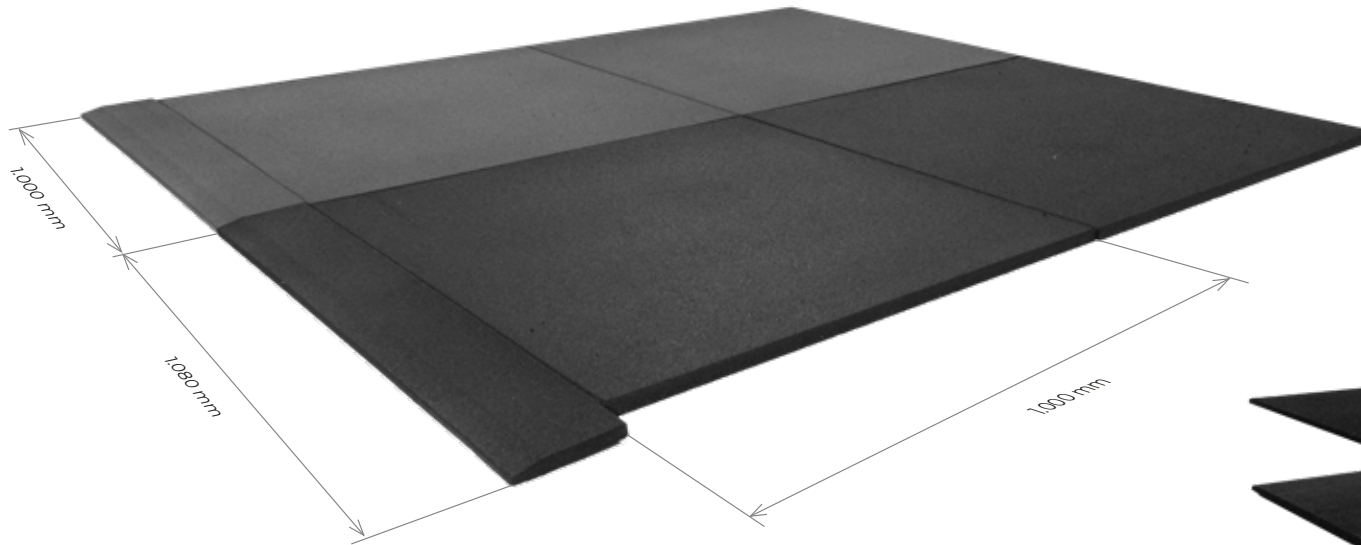

The highly shock-absorbent recycled rubber fitness tiles are manufactured and designed for any open space and/or functional area. The standard rubber tile has a 2-layer system; the bottom layer is made of coarse granules and the top 5 mm layer is made of finer granules. These tiles are manufactured in the EU and are made exclusively from recycled European car tires, which are bound with PU. Due to the exclusive use of high quality raw material, our standard tiles are almost odorless, which makes them suitable even for small, enclosed spaces.

Our new hygiene-only addition to the standard tile range offers additional protection against the spread of bacteria and viruses.

## OUR COLOURS

### Black



20 mm

30 mm

43 mm

53 mm

63 mm

### Gray

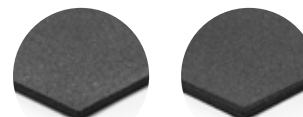

15 mm

20 mm

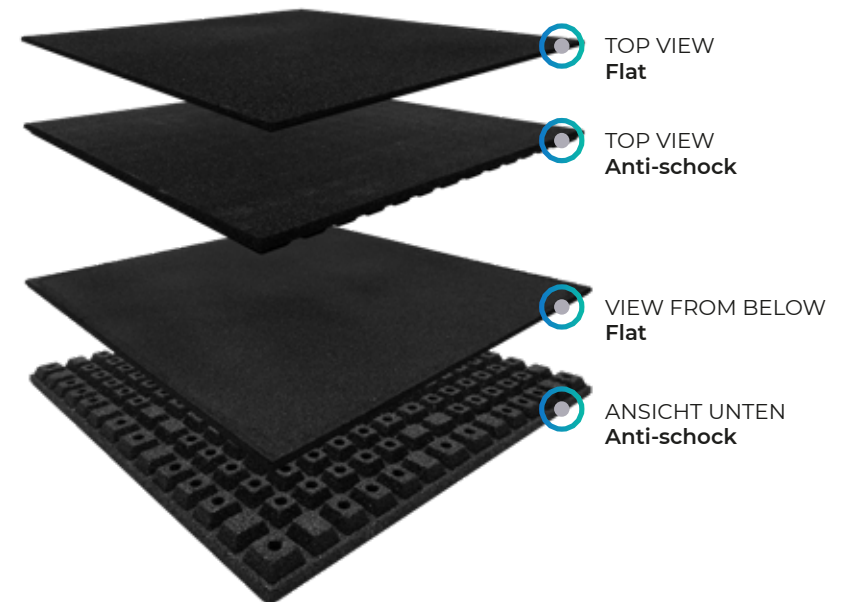
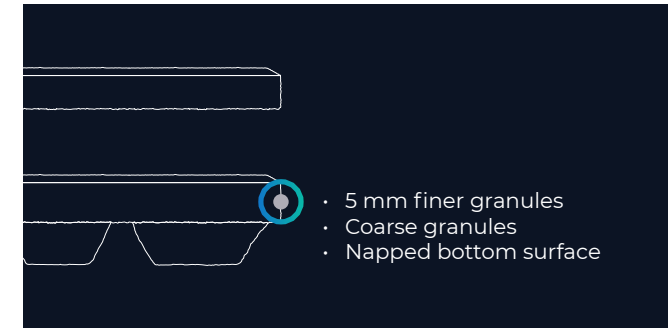

# THE UNDERSIDES

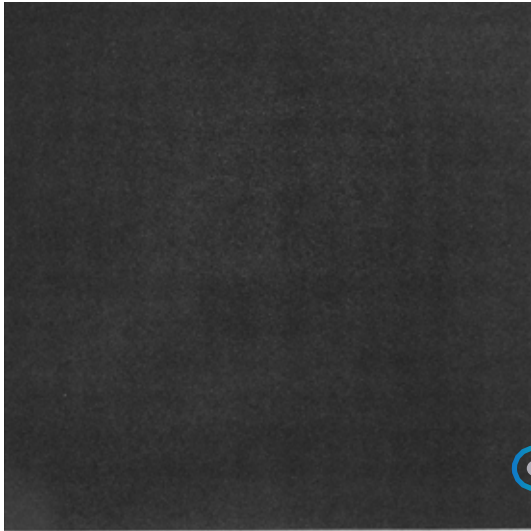

## FLAT

---

A completely flat surface that offers excellent available thicknesses offers excellent durability.

### AVAILABLE THICKNESSES

- 11 mm
- 15 mm
- 20 mm
- 30 mm



Fig.: Standard tile/flat/black - 1,000 x 1,000 mm

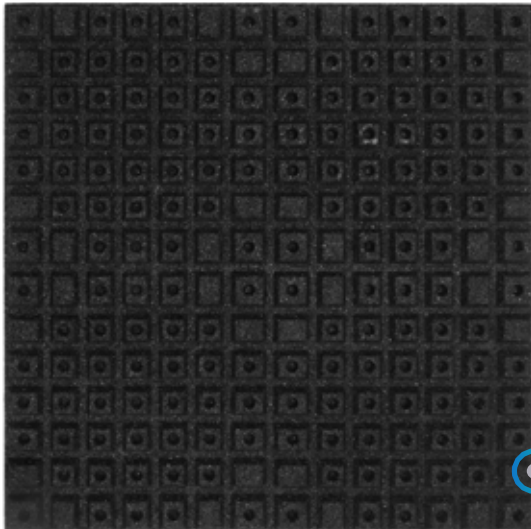

## ANTI-SHOCK

---

Our anti-shock floor is designed to absorb even more sound (for example, impact sound).

### AVAILABLE THICKNESSES

- 43 mm
- 53 mm
- 63 mm



Fig.: Standard Tile/Anti-Shock/Black - 1,000 x 1,000 mm

# ADVANTAGES

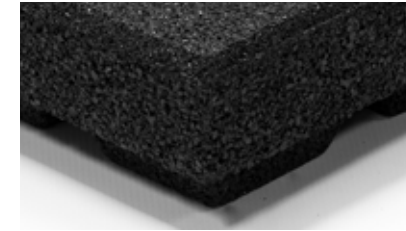

## HIGH DENSITY



## MADE IN EUROPE



## 100% RECYCLED RUBBER USED



## ODORLESS



PERFORM  
BETTER

PRIVAT

# ROLLING RUBBER

The rolled goods are made from predominantly recycled black rubber particles from truck tires - the colored versions have a variants have a proportion of new EPDM. As a result of the exclusive use of tires, this flooring has a very fine, smooth surface. surface.

Our highly compact and maximally robust rubber floor covering is immune to moisture and water, elastic, impact sound absorbing and is suitable for a wide range of applications:

Exhibitions, trade shows and exhibition stands, fitness centers, Crossfit-Boxes, recreation rooms, sports centers, dressing rooms, ice rinks, mountain resorts, shooting ranges, horse transport, rooms of of golf courses, etc.



## OUR COLOURS

### PURE BLACK

SBR rubber granulate bonded with PUR



black

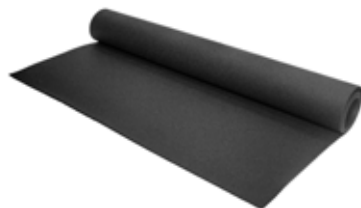

### FIVE

95 % SBR and 5 % EPDM rubber granules, bonded with PUR

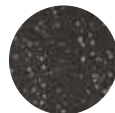

grey



blue



lila



orange

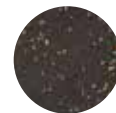

yellow



red



samba



stars

## DENSITY

Our rolling floors are available in a thickness suitable for any purpose. From 4 mm up to 14 mm in 2 mm increments.

Our standard roll width is 1.25 meters.



Cardio training, spinning, physiotherapy, yoga, exhibition, substrate protection etc.



gym, aerobics, shooting range



Functional training, martial arts



Ice skating rink, mountain/cable car station, ski rental, free weight areas middle weights

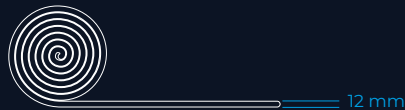

Free weight areas heavyweight, CrossTraining

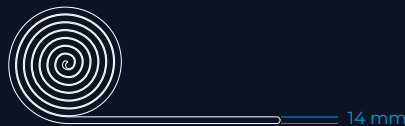

## ADVANTAGES



HIGH DENSITY



MADE IN EUROPE



100% RECYCLED RUBBER USED



ODORLESS



# OUTDOOR Tiles

The highly shock-absorbent recycled rubber fitness tiles are manufactured and designed for each Open space and/or functional area manufactured and designed. The standard rubber tile has a 2-layer system; the bottom layer is made of coarse granules and the top layer of 5 mm, consists of finer granules.

These tiles are manufactured in the EU and are made exclusively from recycled European car tires, which are bound with PU. The two different floor structures are specially designed to channel (rain) water through and away from the training area.

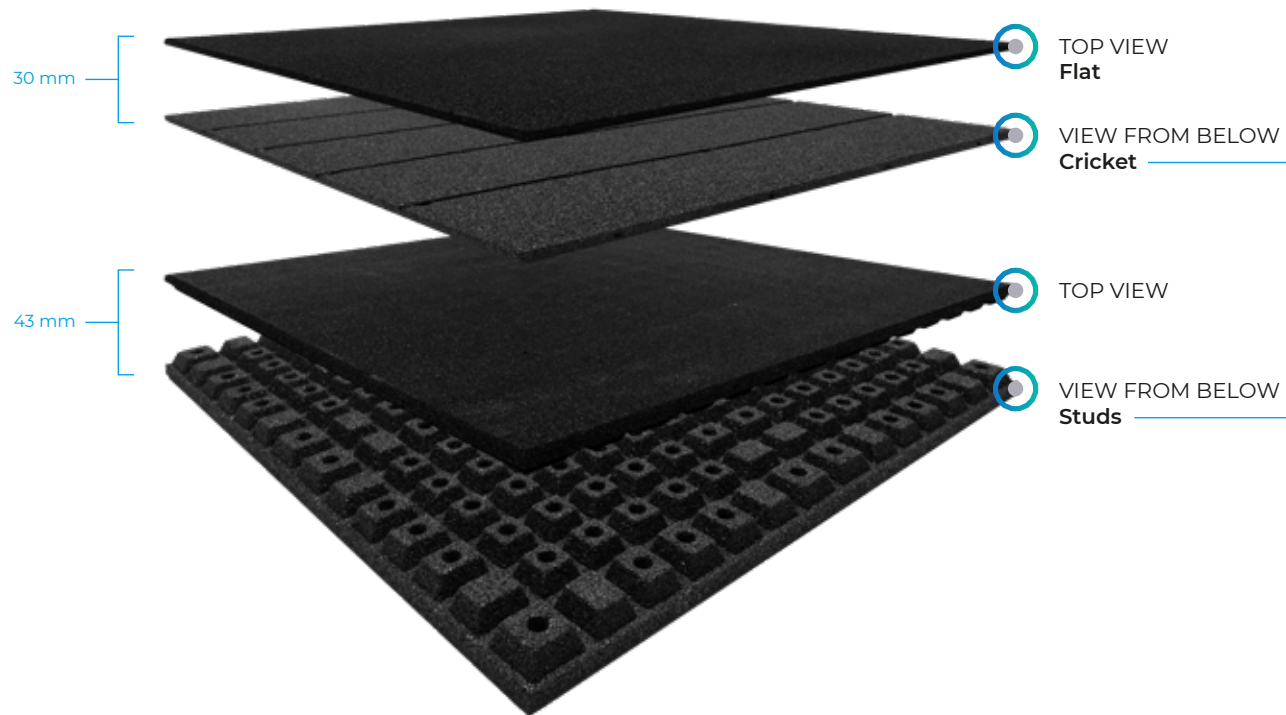

## DIMENSIONS

All outdoor fitness plates are 1 x 1 meter in size. They are available in available in thicknesses of 30 and 43 mm.

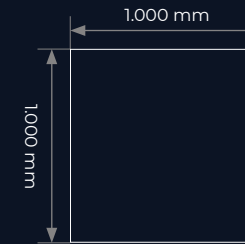

An almost closed floor surface with strategically placed drainage channels that give these variants excellent durability and ease of use.

Our studded floor is designed to withstand the toughest wear and tear while ensuring water drains efficiently through the many openings.



## THE PEN SYSTEM

A pin hole is placed every 25 centimeters, resulting in an average of 4 pins per meter. This keeps the interconnected tiles firmly in place. This results in a phenomenal free-floating system that is achieved without glue or other complicated installation methods.

To visually minimize expansion and contraction of the tiles due to weathering we recommend closing the tile seams with an MS polymer adhesive.

## CONNECTIONS

Our outdoor fitness tiles are easy to install with the pin connector system, no adhesive is required. The edges can be covered with a stainless steel profile. The tiles can be easily cut to the right size with a hand knife, we recommend the use of carpet knives (cutters) for this purpose.



Fig.: Outdoor Fitness Tile - 1.000x1.000x30 mm + PIN CONNECTORS

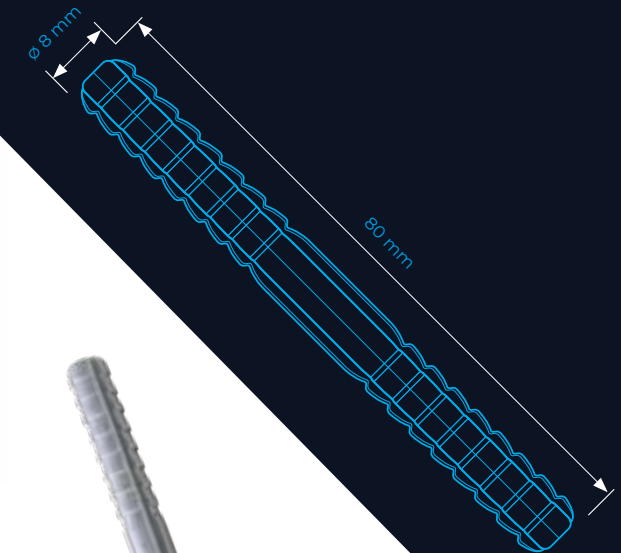

## ADVANTAGES

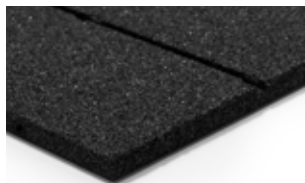

HIGH DENSITY



MADE IN EUROPE



100% RECYCLED RUBBER  
USED



DESIGNED FOR OUTDOOR  
USED



# PUZZLE Tiles

The Sportsflooring puzzle tiles are made primarily from recycled black rubber particles from truck tires. the colored variants have a proportion of new EPDM in the a proportion of virgin EPDM. As a result of the exclusive of truck tires, this floor covering has a very fine and a very fine and smooth surface.

Our highly compact and maximally robust rubber floor covering is insensitive to moisture and humidity, rot-proof, elastic, impact sound absorbing and is suitable for a wide range of applications: Exhibitions, trade shows and booths, fitness centers, cross-training Boxes, recreation rooms, sports centers, dressing rooms, ice rinks, hill stations and many other facilities.

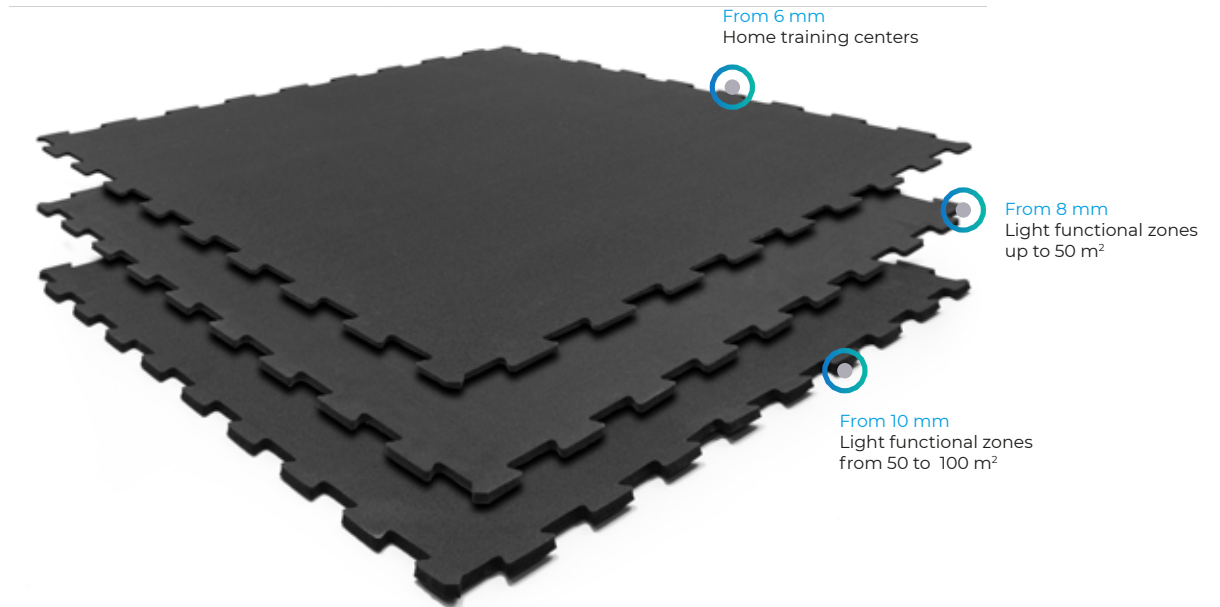

## OUR COLOURS

### PURE BLACK

SBR rubber granulate bonded with PUR

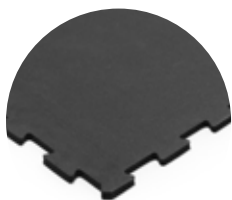

black

### FIVE

95 % SBR and 5 % EPDM rubber granules, bonded with PUR



grey



blue



lila



orange



yellow



red



samba



stars

## DENSITY

Our puzzle tiles are available in a thickness thickness suitable for any purpose.

From 6 mm up to 10 mm, in 2 mm increments. Our standard puzzle dimensions are 60 x 60 cm and 100 x 100 cm.

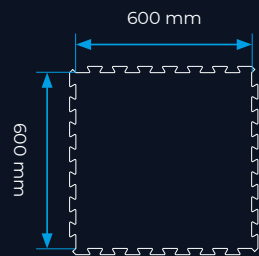
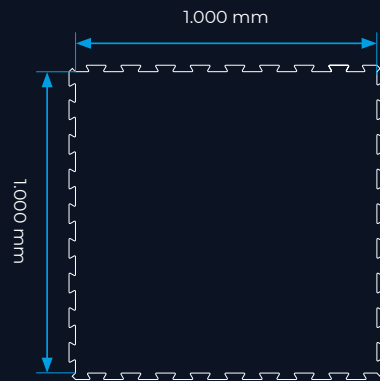

## ADVANTAGES



INTERLOCKING PUZZLE SYSTEM



MADE IN EUROPE



100% RECYCLED RUBBER USED



ODORLESS







# RIG & Rack



# PB STEEL Rig & Rack

## DESIGN YOUR PB STEEL RIG & RACK NOW

Looking for a new centerpiece for your Functional Zone? Then PB Steel is the right modular RIG system for you.

Our RIGs are expandable, quickly deliverable and maximally flexible in design. Manufactured in Europe in close collaboration with design, product and training experts. Create your customized RIG (indoor as well as outdoor) with the highest level of flexibility and design. We deliver your RIG fast and reliable.



## FEATURES

- Custom & Standard Options
- Maximum color variety
- Wide range of attachments
- High quality steel 80 x 80 mm / 4 mm thickness
- Ruggedness
- Laser cut & powder coated
- Logo branding
- Easy and fast installation
- Premium Quality
- Made in Europe



## COLOR VARIETY

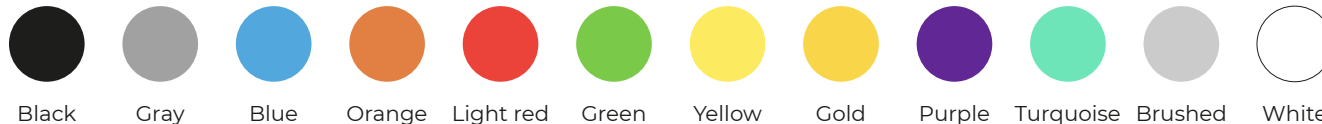

# FEATURES

## INDOOR RIGs

Coating warranty:	2 years
Steel warranty:	Lifetime
Warranty:	2 years
Outdoor:	No
Series:	Mighty
Dimensions:	80 x 80 mm
Material:	Steel
Width:	2704 mm
Height:	2750 mm
length:	3486,76 mm
SKU:	KB04MI-026

## OUTDOOR RIGs

Coating:	Hot-dip galvanized and Powder coated
Coating warranty:	7 years
Steel warranty:	Lifetime
Outdoor:	Yes
Dimensions:	80 x 80 mm
Material:	Steel
Width:	4820 mm
Weight:	606 kg
Height:	4500 mm
length:	1700 mm
SKU:	KB01MI-011

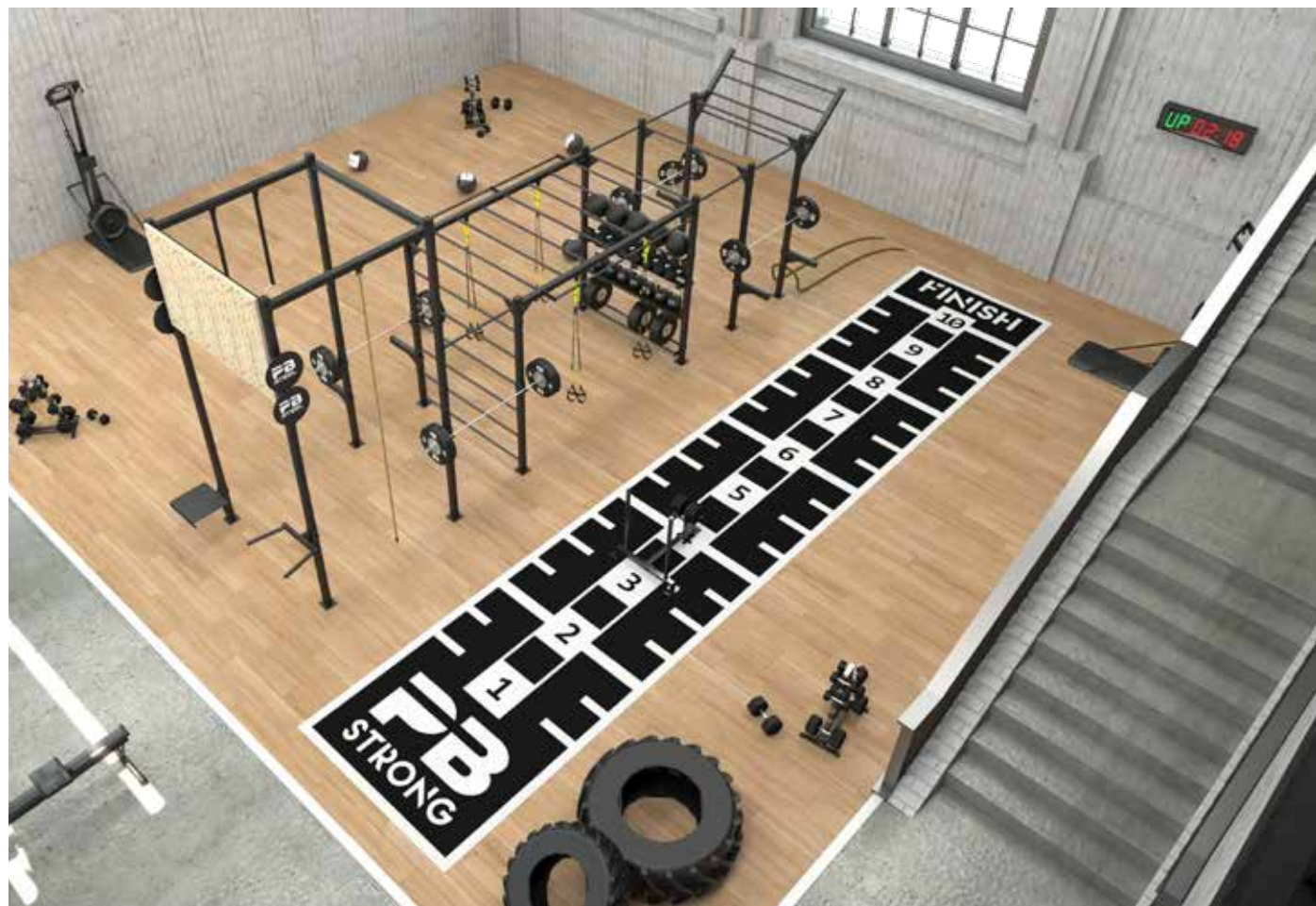

# ◎ PB STEEL – CLIMBING TOWER

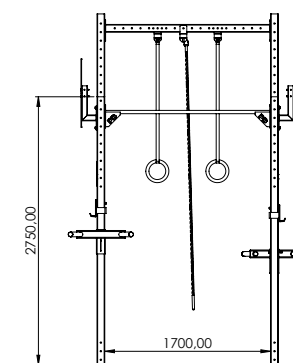
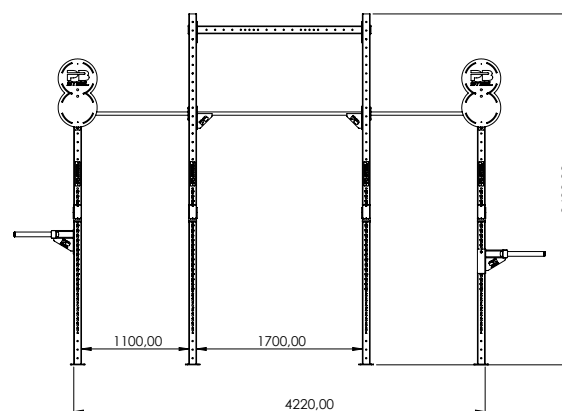

## TOOLS

- 4 x Upright for Mighty Rig 275cm
- 4 x PU Bar S 1700
- 4 x PU bar S 1100
- 4 x Upright for Mighty Rig 360cm
- 4 x Universal Profile F 1700
- 3 x Iron Hand Mighty
- 4 x Mighty J-Cups
- 4 x Double WB Target
- 2 x Side Dip Bar



# ◎ PB STEEL – CROSS RIG

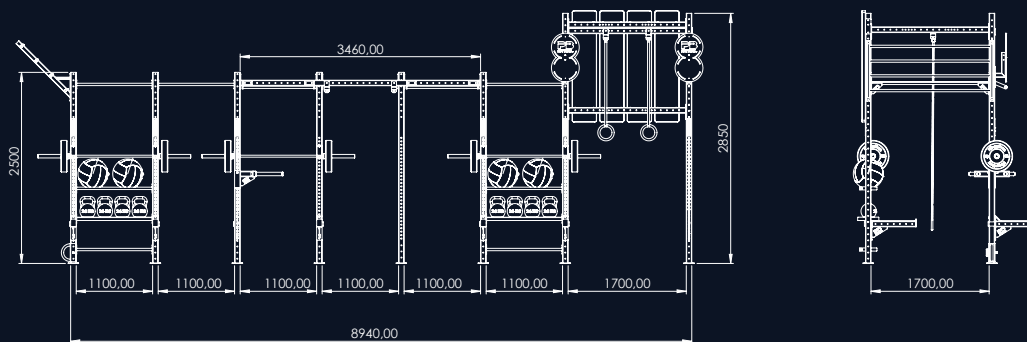
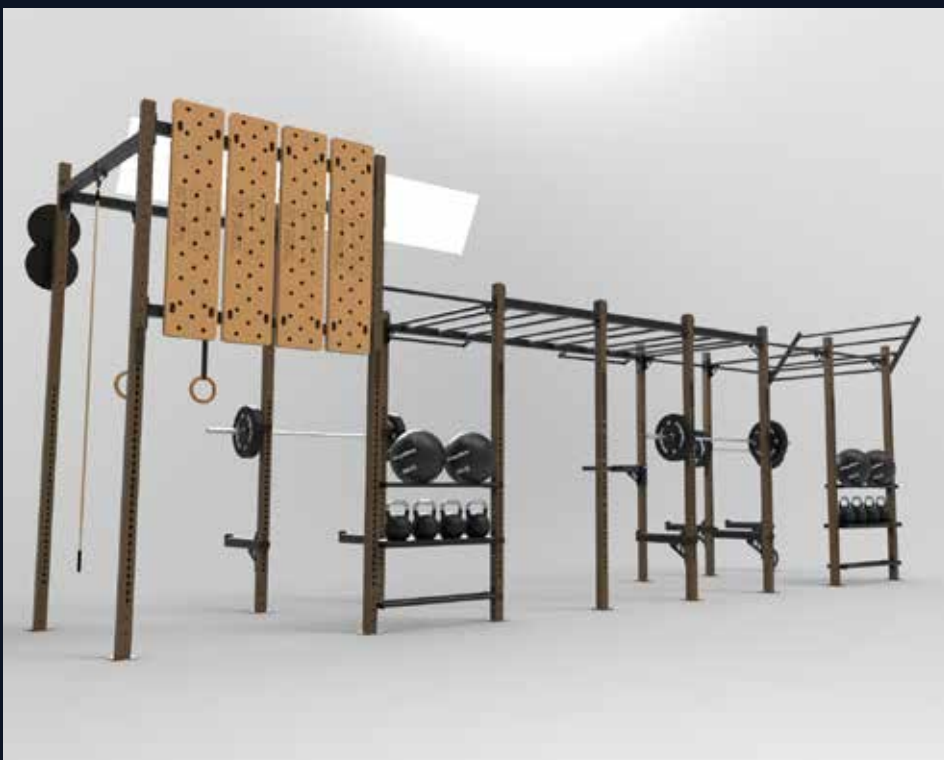

## TOOLS

- 1 x Lestev za Rig 170cm (za Mighty Rig)
- 1 x Universal Profile F 3460
- 1 x Upright for Mighty Rig 2.0 360cm
- 1 x Rope Plezalna Vrv - 3m
- 1 x Kljuka za Battle Rope (Za Mighty Rig)
- 1 x Side Dip Bar
- 2 x Monkey Mount S PU Bar 1038
- 2 x Double WB Target
- 2 x Royal Wood Rings
- 3 x Universal Profile F 1100
- 3 x Upright for Mighty Rig 360cm
- 3 x Safety Arms
- 3 x Mighty J-Cups
- 4 x Upright for Mighty Rig 2.0 275cm
- 4 x Slamball Shelf 1100
- 5 x PU bar S 1100
- 5 x Universal Profile F 1700
- 5 x Iron Hand Mighty
- 6 x Upright for Mighty Rig 275cm
- 8 x KETTLEBELL 24KG
- 9 x PU Bar Monkey S 1700
- 4 x PU Bar S 1700
- 2 x Kettlebell Shelf 1100
- 4 x Rig Peg Board

# ◎ PB STEEL – CROSS RIG (PEGBOARD LATERAL)

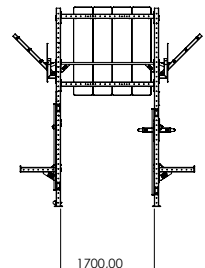
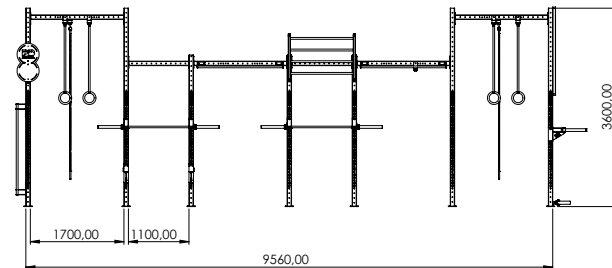

## TOOLS

- 1 x Side Dip Bar
- 1 x Mighty Rig Landmine
- 2 x Double WB Target
- 2 x Lestev za Rig 110 cm (za Mighty Rig)
- 3 x PU Bar S 1700
- 4 x Royal Wood Rings
- 2 x Safety Arms
- 4 x Rig Peg Board
- 4 x Universal Profile F 1100
- 4 x Mighty J-Cups
- 6 x Monkey Mount S PU Bar 1566
- 8 x Upright for Mighty Rig 2.0 360cm
- 6 x Upright for Mighty Rig 275cm
- 8 x Iron Hand Mighty
- 10 x PU Bar Monkey S 1700
- 13 x Universal Profile F 1700

# ◎ PB STEEL – FITNESS RIG

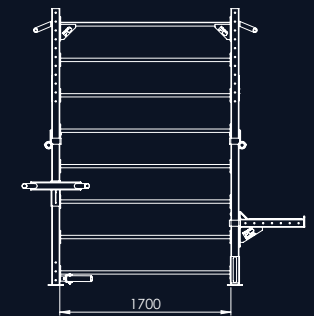
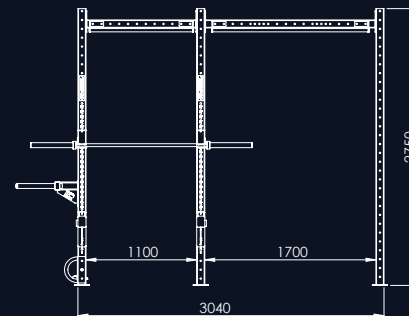

## TOOLS

- 1 x Safety Arms
- 1 x Side Dip Bar
- 1 x Battle Rope Hook
- 1 x Mighty Rig Landmine
- 2 x Upright F 2750 Stall
- 2 x Universal Profile F 1100
- 2 x PU Bar S 1700
- 2 x Universal Profile F 1700
- 2 x Monkey Mount S PU Bar 1038
- 2 x Monkey Mount S PU Bar 1566
- 2 x Mighty J-Cups
- 4 x Upright for Mighty Rig 275cm
- 11 x PU Bar Monkey S 1700

# ◎ PB STEEL – FUNCTIONAL RIG

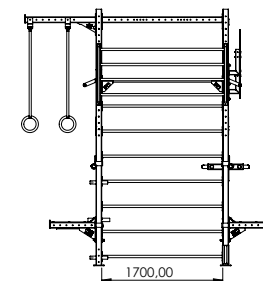
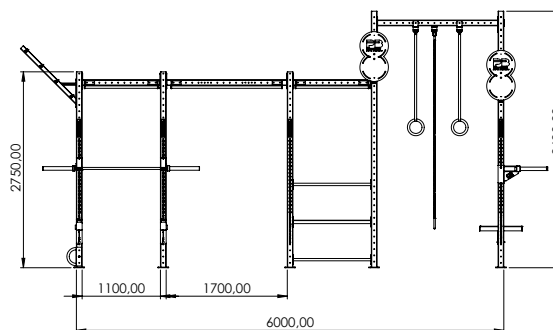

## TOOLS

- 5 x Upright for Mighty Rig 275cm
- 3 x PU Bar S 1700
- 2 x Upright F 3600 Stall
- 6 x Universal Profile F 1700
- 2 x Upright for Mighty Rig 360cm
- 5 x Iron Hand Mighty
- 1 x Lestev za Rig 170cm (za Mighty Rig)
- 2 x Mighty J-Cups
- 16 x PU Bar Monkey S 1700
- 1 x Battle Rope Hook
- 2 x Double WB Target
- 1 x Side Dip Bar
- 2 x Safety Arms
- 1 x Upright F 2750 Stall
- 4 x Universal Profile F 1100
- 2 x Slamball Shelf 1100
- 1 x Kettlebell Shelf 1100
- 1 x Royal Branch F
- 1 x Mighty Plyo Platforma
- 2 x Monkey Mount S PU Bar 1566
- 3 x Monkey Mount S PU Bar 1038

# ◎ PB STEEL – TRAININGS TOWER

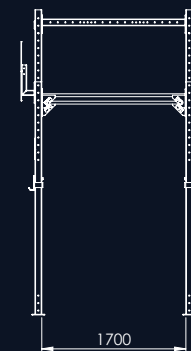
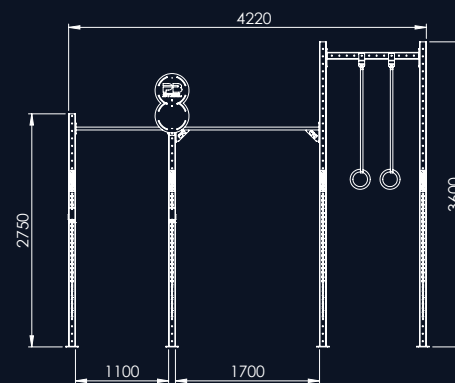

## TOOLS

- 2 x PU bar S 1100
- 2 x Universal Profile F 1700
- 2 x Universal Profile F 1100
- 2 x Mighty J-Cups
- 4 x Upright for Mighty Rig 275cm
- 4 x Upright for Mighty Rig 360cm
- 4 x Iron Hand Mighty
- 4 x Royal Wood Rings
- 5 x PU Bar S 1700
- 1 x Double WB Target

# ◎ PB STEEL – WALL RIG

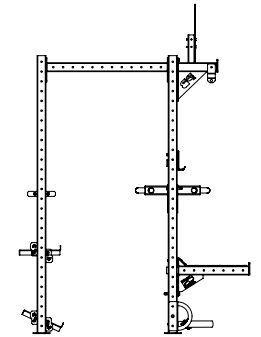
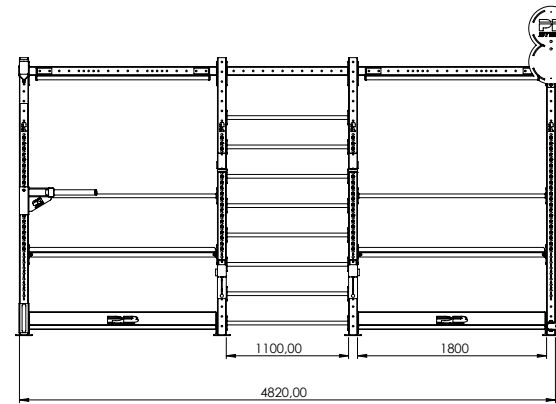

## TOOLS

- 8 x Upright Rack Mighty 2500
- 8 x PU bar S 1100
- 6 x Universal Profile F 1100
- 4 x DB KB Shelf 1700
- 4 x Universal Profile F 1700
- 1 x PB Mini Branch F
- 1 x Iron Hand Mighty
- 1 x Battle Rope Hook
- 1 x Mighty Rig Landmine
- 1 x Safety Arms
- 1 x Mighty J-Cups
- 1 x Double WB Target
- 1 x Side Dip Bar
- 1 x Monkey Mount S PU Bar 1566

# ◎ PB STEEL – WEIGHT-LIFTING RIG

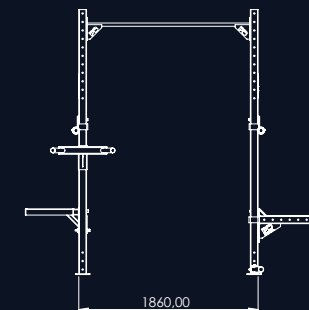
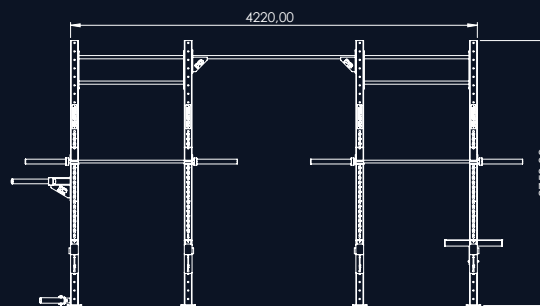

## TOOLS

- 1 x Side Dip Bar
- 1 x Mighty Plyo Platform
- 1 x Mighty Rig Landmine
- 2 x Safety Arms
- 4 x PU Bar S Double 1100
- 4 x Mighty J-Cups
- 6 x PU Bar S 1700
- 8 x Upright for Mighty Rig 275cm

# ◎ PB STEEL – FITNESS Rack

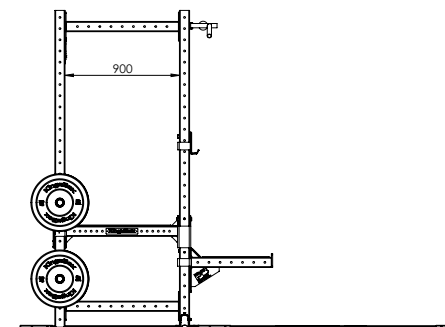
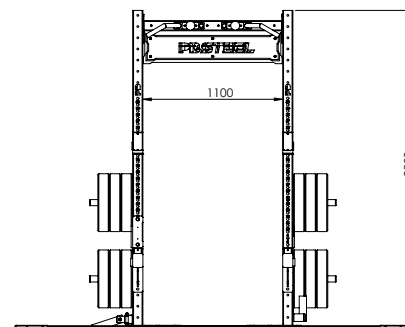

## TOOLS

- 1 x Universal Profile F 1100
- 1 x Manifesto Sign III
- 1 x Monkey Profile 1100 F
- 1 x PB Sign Text Plate
- 1 x Modular Angled S Grip L
- 1 x Modular Angled S Grip D
- 1 x Mighty J-Cups
- 1 x Mighty Rig Landmine
- 1 x One Bar Rack BL
- 1 x Rack Platform
- 1 x Mighty Safety Catchers 900
- 1 x Safety Arms
- 2 x Modular Neutral S Grip
- 2 x PU 70 Sphere S
- 4 x Upright Rack Mighty 2500
- 4 x Linked profile 900F
- 4 x Mighty Mortar Bumper Rack



# PERFORM BETTER



FTC Functional Training Company GmbH  
Perform Better Europe  
Balanstr. 73 / D-81541 München

Telefon: +49 (0) 89 4444679-250  
E-Mail: [info@perform-better.de](mailto:info@perform-better.de)

[www.perform-better.de](http://www.perform-better.de)